



# PATIOKITS DIRECT

- How to Measure
- Design Options
- Add-on Options
- Frequently Asked Questions



# Insulated vs. Non-Insulated - What's the Difference?



[Click Here to Watch Video!](#)

Then come back to this file to learn even more!

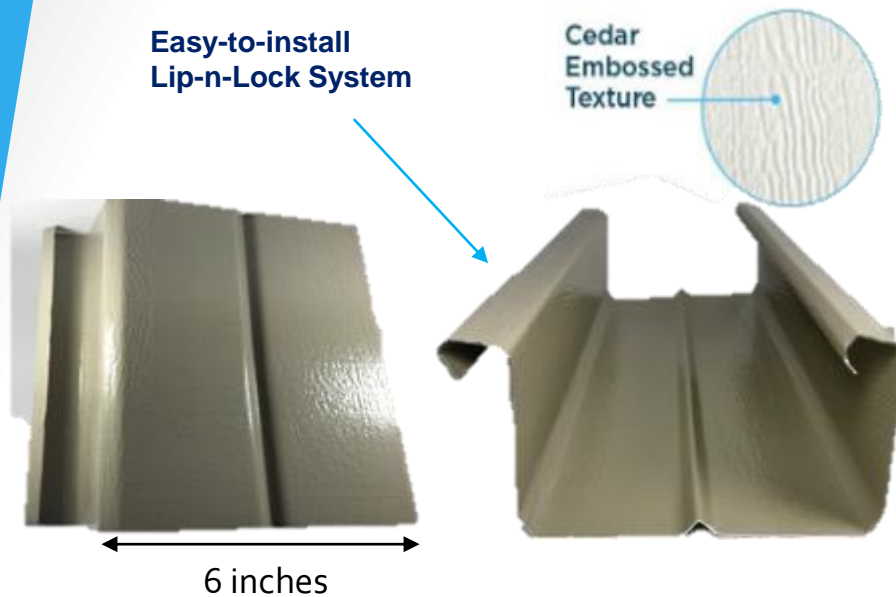

## Solid Non Insulated (Newport)

- Our most popular cover!
- .018-.036 gauge aluminum "W" pans
- 6" lengths, with view from top looking like multiple W's
- Lip-n-lock system (channel locks without need for caulking)
- Available in any color (8 color options)



## Solid Insulated (Maxx Panel)

- 3 inch foam core, panels come in 4' increments (can be cut on-site to accommodate other sizes)
- Allows about a 5 degree temperature decrease
- Looks the same on top as on bottom (ideal for two story homes, if you care what it looks like 'looking down' on the cover)
- Available in White and Desert Sand only

**NOTE:** Insulated material & shipping costs a significant amount more. Because of this, unless you live in an extreme-temperature area, or want the aesthetic "looking down", we recommend opting for the non-insulated option (our most popular!) - 😊 **We love saving our customers money!**

# Lattice Laguna

[Click Here to Watch Video!](#)

Then come back to this file to learn even more!

Lattice Tubes

2x2 – 2" spacing (50% coverage)

2x3 – 1" spacing (60% coverage)

1.5x1.5 – 2" spacing (40% coverage)

3x8 Header beam  
3x8 Header beam

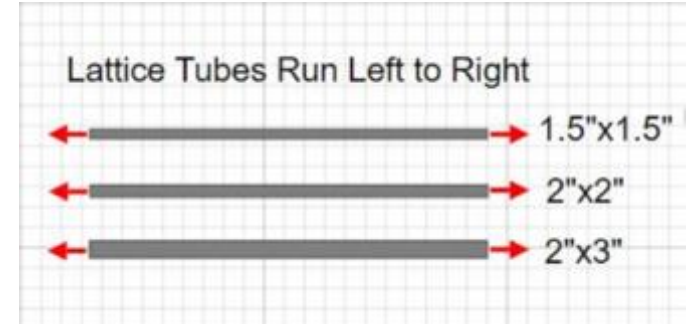

2x6 rafter – 24" on center standard

2x6 sideplate (part of post kit)

# Attachment Options



Wall attachment  
(Stucco application)



Eave Attachment



Roof Attachment



Free Standing  
(Steel Posts in concrete footings)

# How to Measure your Patio Dimensions



[Click Here to Watch Video!](#)

Then come back to this file to learn even more!

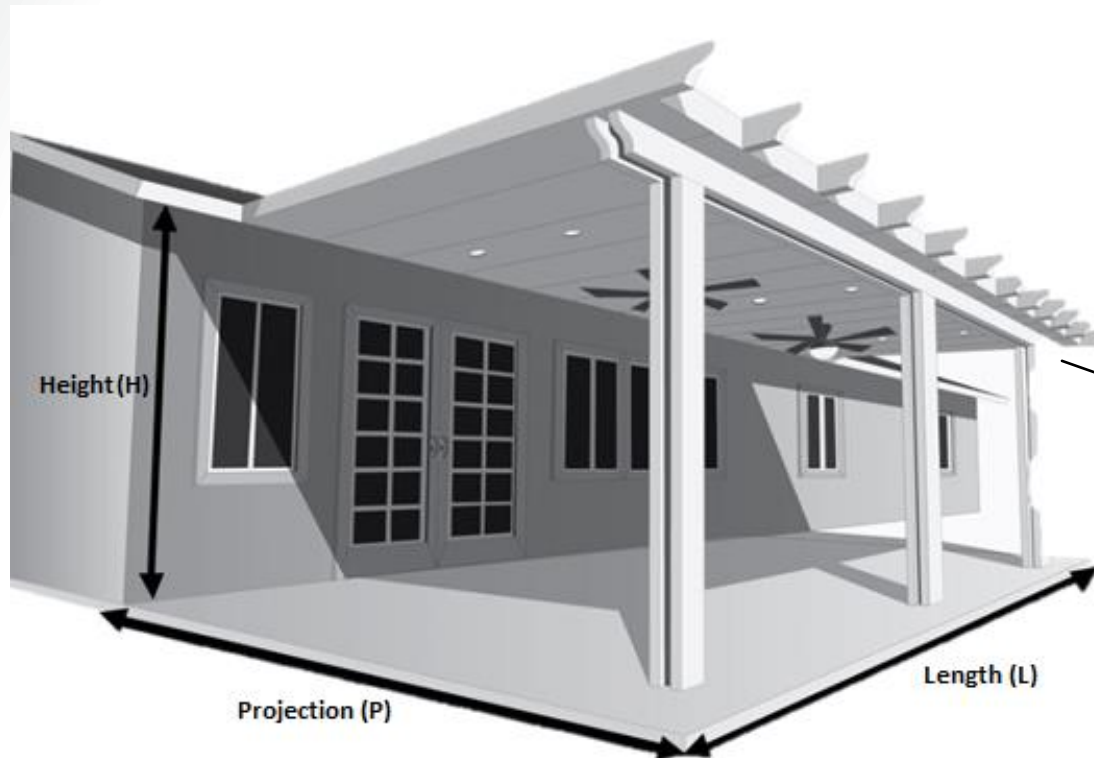

(P) Projection [from house]

(L) Length [side to side]

(H) Height [to attachment]

NOTE: For freestanding, simply envision the house as the second beam and post set

- 'Dimensions' refer to the total shade portion (roofing), posts will sit 1' – 1.5' in from the total ceiling projection.
- Length dimension should be total ceiling cover from left to right. Posts are placed 1'-1.5' in on each side.
- The post placement is considered the "footprint". The roofing measurement is considered total "dimensions".
- The height dimension is the height to the point of wall/eave attachment.

# How to Measure your Patio Dimensions

Example Lay out

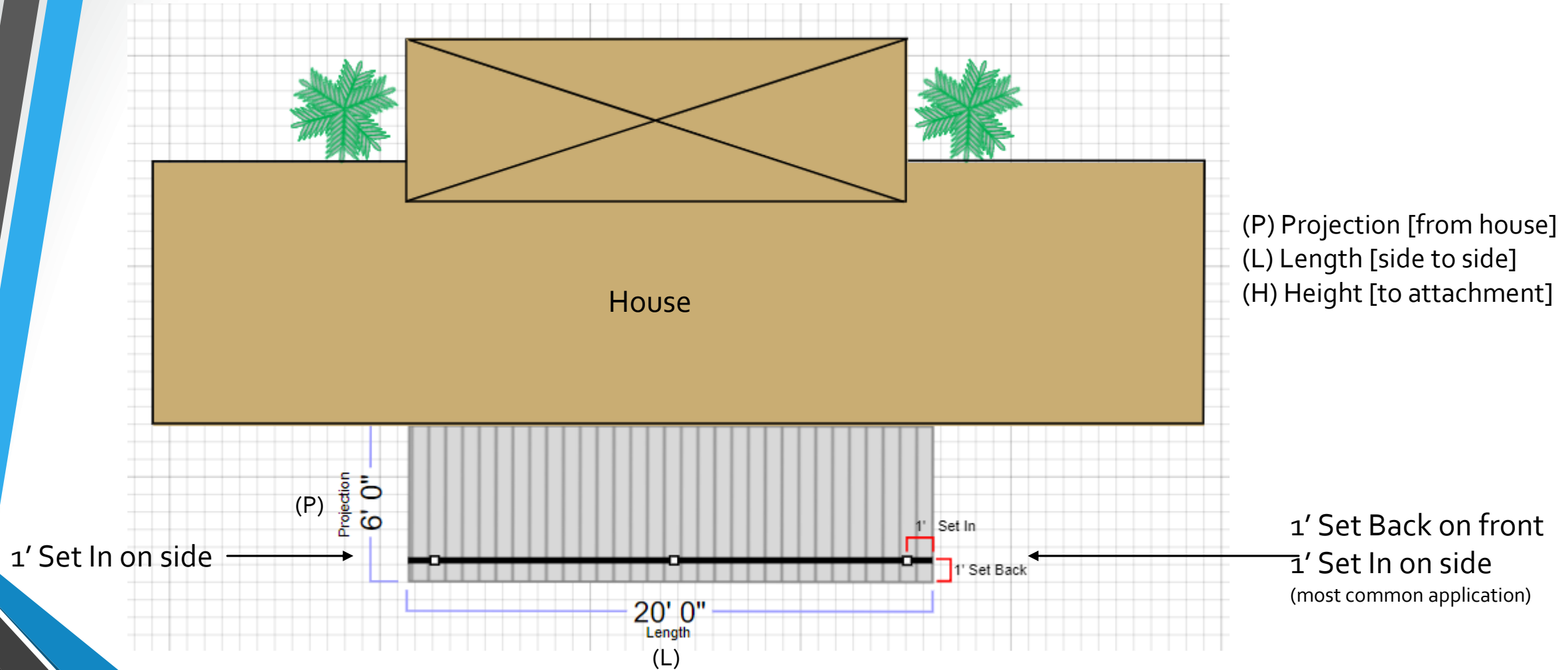

# How to Measure your Patio Dimensions



Irregular House Dimensions/ Pop Outs?

 [Click Here to Watch Video!](#)

Then come back to this file to learn even more!

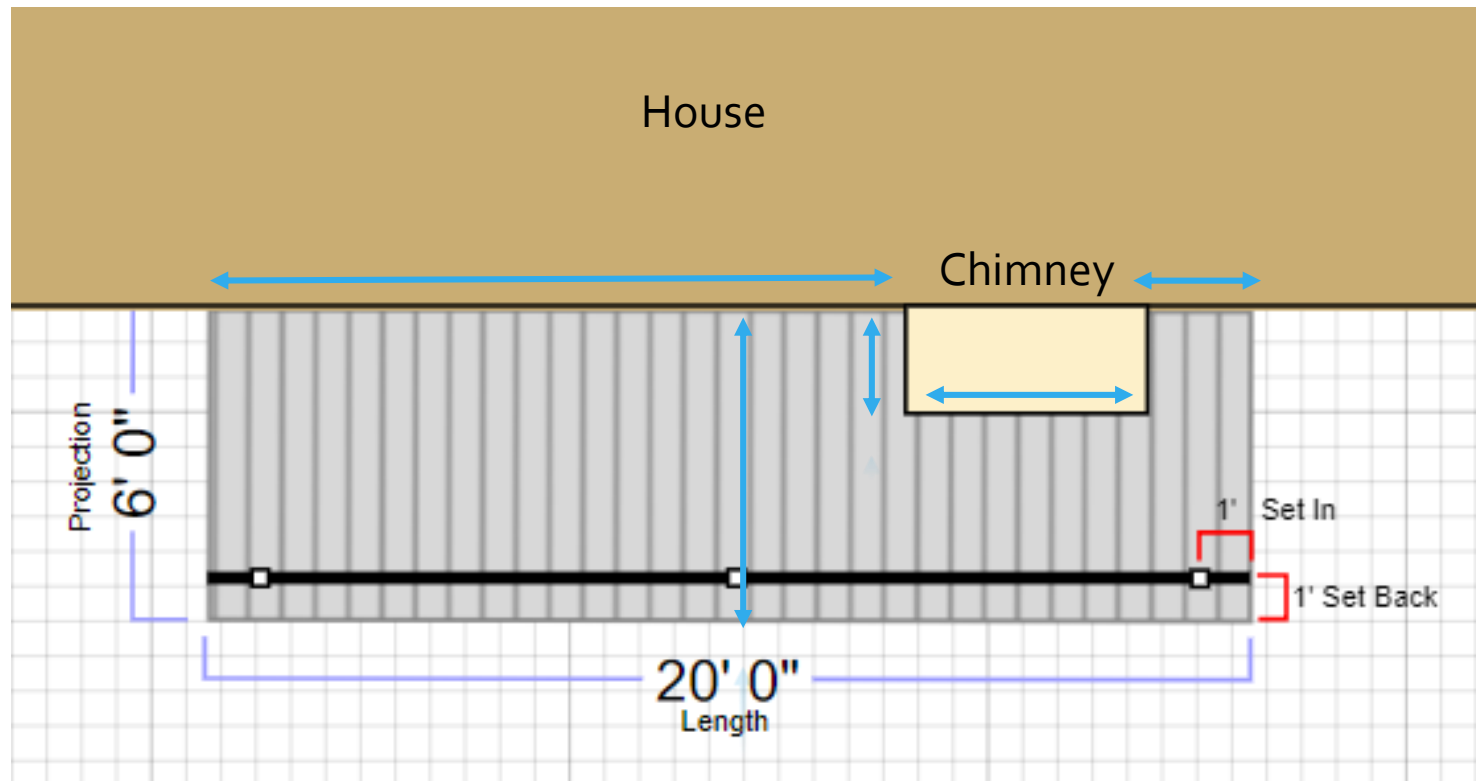

If you have an irregularly shaped house, or a pop out (like a chimney), simply give us the dimensions for the pop out

See arrows in diagram to left



You can even send us a quick sketch and include these dimensions and we can custom design for you!

# How to Measure your Freestanding Patio Dimensions



[Click Here to Watch Video!](#)

Then come back to this file to learn even more!

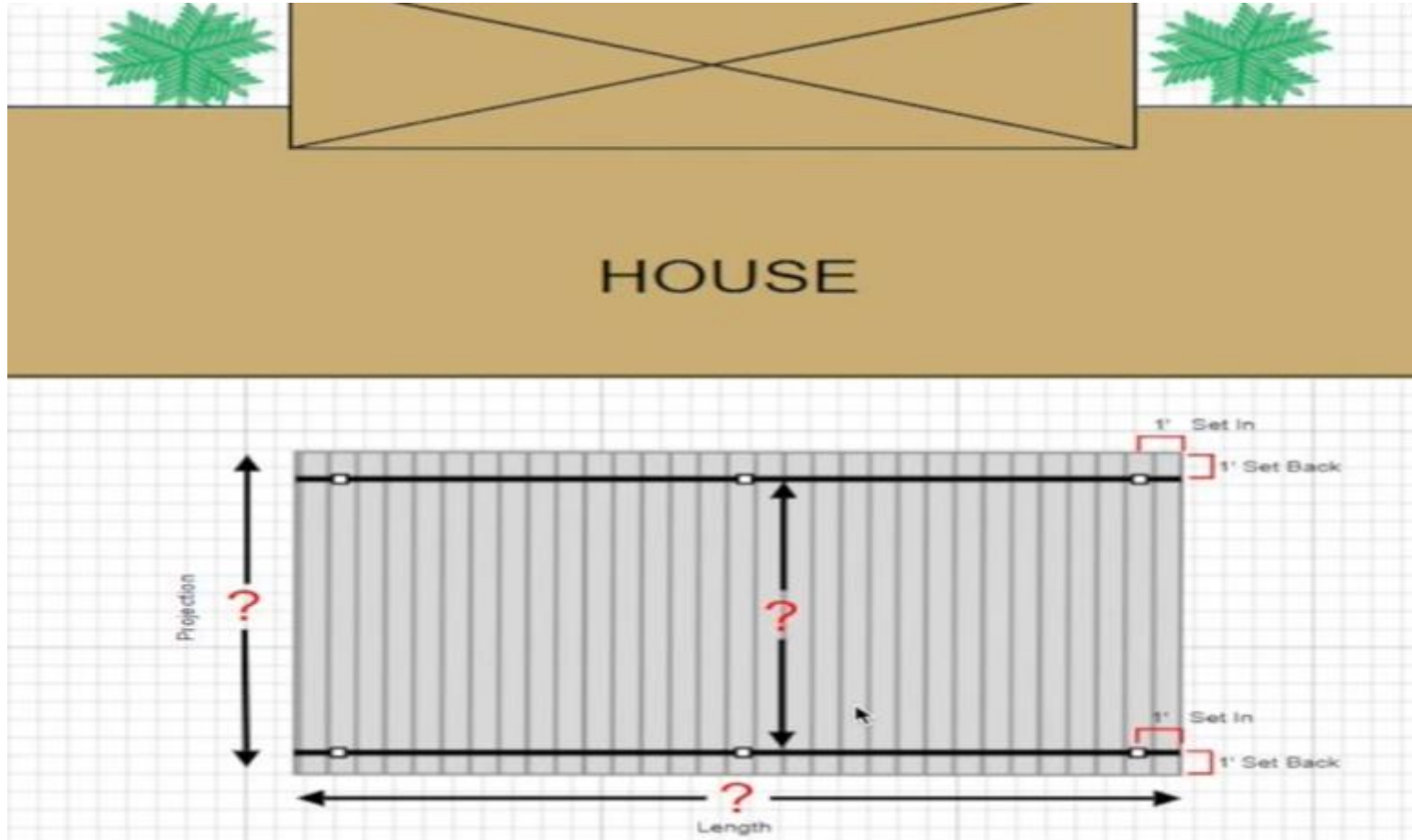



# FAQ – Can I get a Combination Cover?

 [Click Here to Watch Video!](#)

Then come back to this file to learn even more!

- You can order a custom cover that is a combination of lattice and solid.
- Change in cover type must occur on the length dimension (side to side), not on the projection. This is due to beam requirements for roofing stability, see below.
- See next slide for what dimensions are needed.

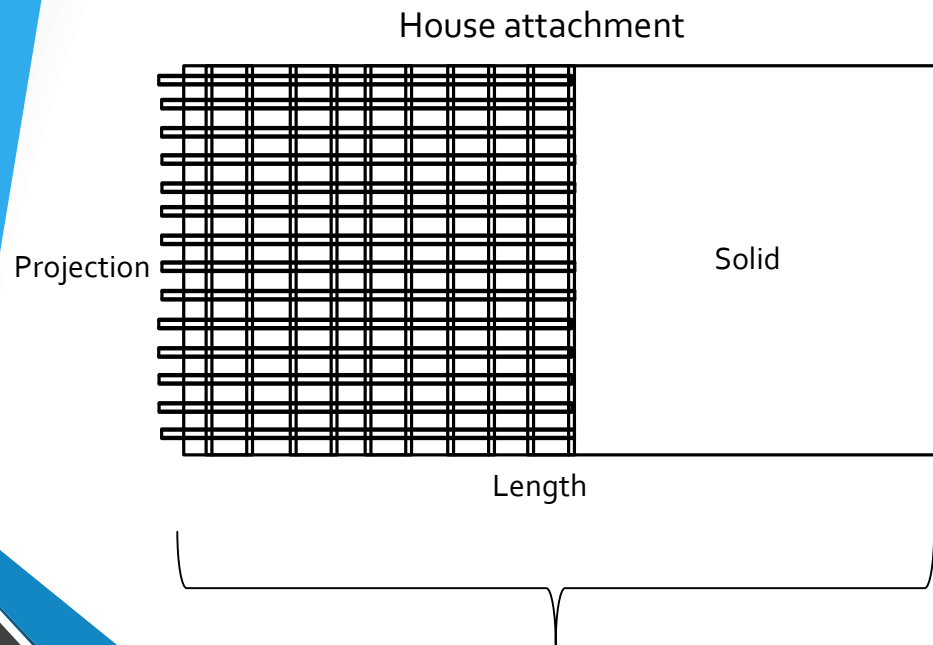

Change occurs on the **LENGTH** dimension

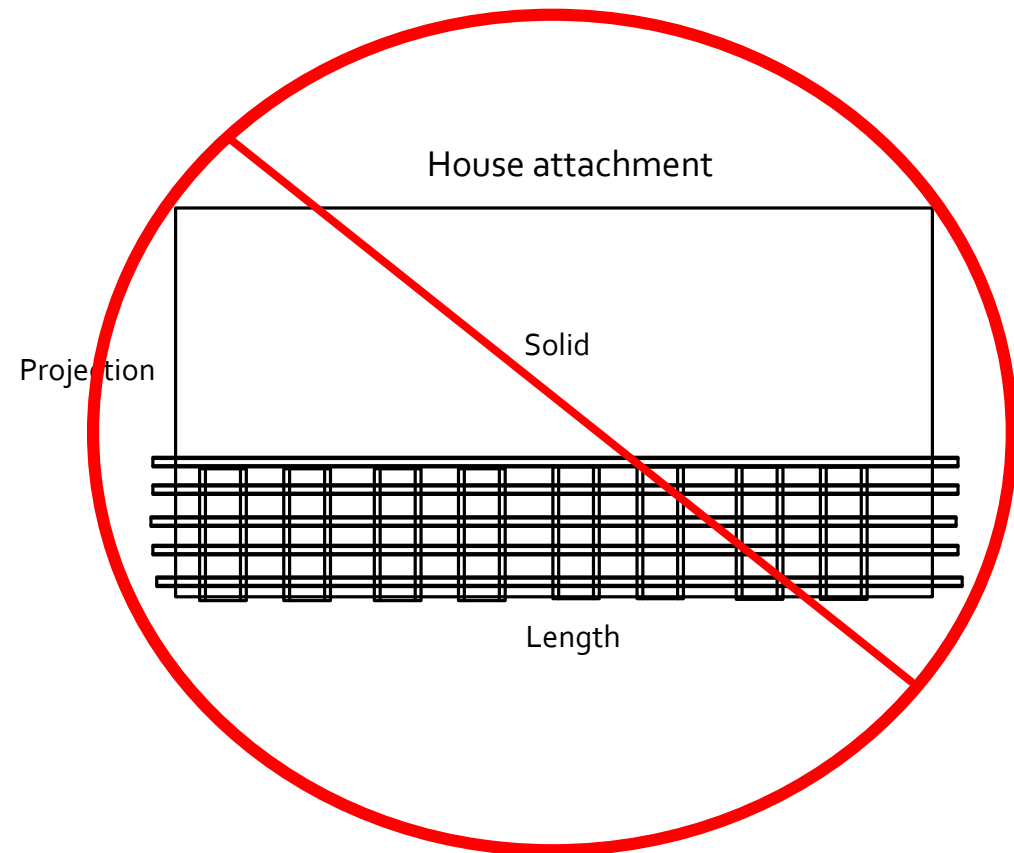

# FAQ – What dimensions are needed for a Combo Cover??



[Click Here to Watch Video!](#)

Then come back to this file to learn even more!

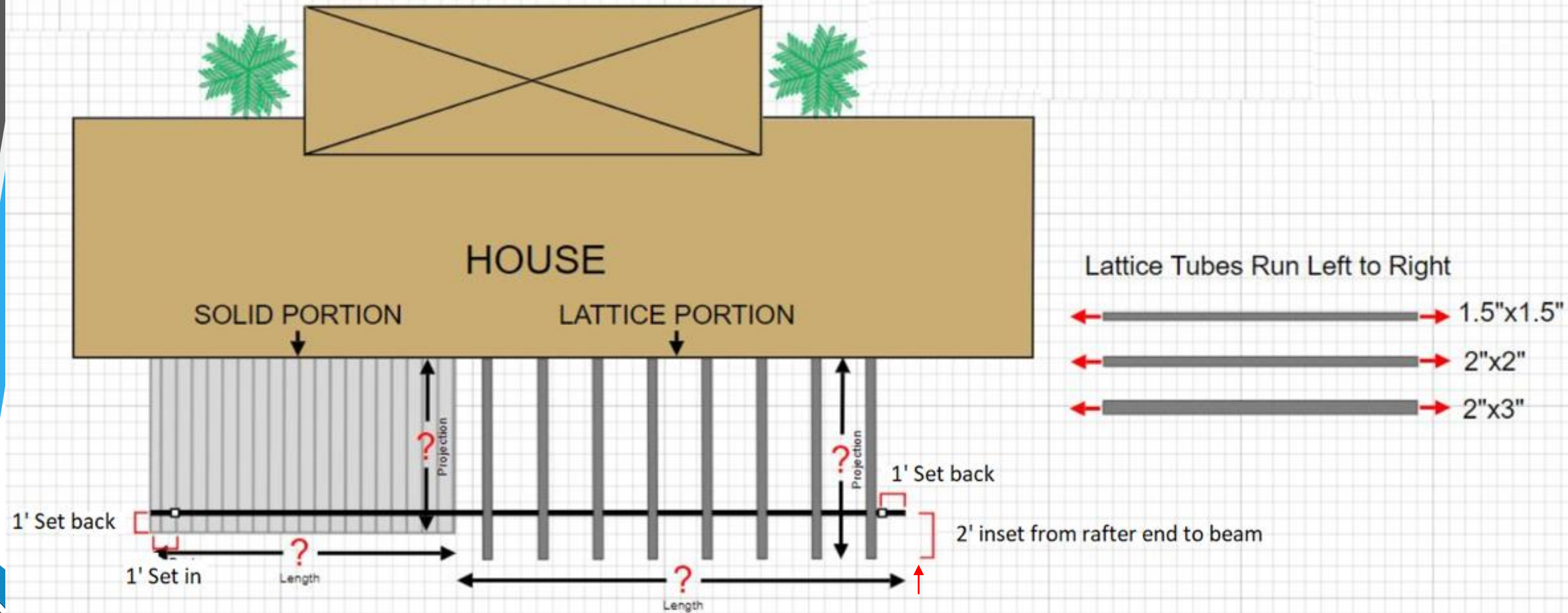

**NOTICE:** For Combo covers, the Lattice Projection should be 1' longer than the solid so that they line up with the rafter tails

# Can I order an "L-shaped" Patio Cover?



- You can order a custom cover that is an "L-Shape"
- Just make sure to provide us with the dimensions listed below!
- Most L-Shaped Covers have the break (change in projection) either "on the beam" or "on the house"
- A variety of L-shape applications can be achieved
- You can even do a Free Standing L-Shape with no house attachment!

## Other (Less Common) L-Shape Applications

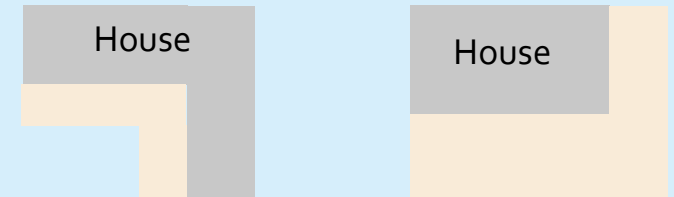

▶ [Click Here to Watch Video!](#)

▶ [Click Here to Watch Video!](#)

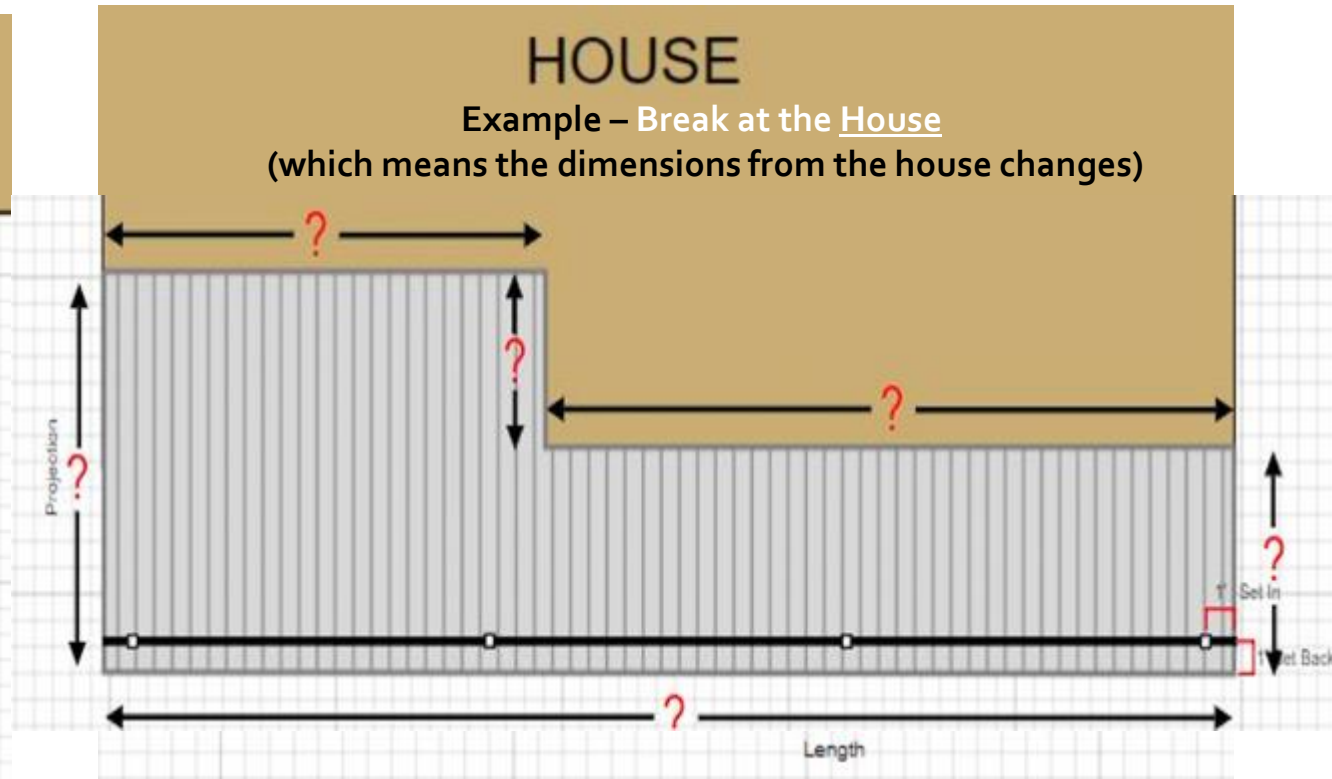

# Standard Post Kits vs. Fiberglass Columns – Optional Adder



[Click Here to Watch Video!](#)

Then come back to this file to learn even more!

## Alumawood Standard Post Kit

- Includes a 3x3 Alumawood (Aluminum) post and 2 2x6.5" foam-filled sideplates.
- Standard post kits are included at no extra charge in each KIT.

## Fiberglass Columns

- This is an Add-on product
- Fiberglass columns with Tuscan decorative caps and bases
- Columns/caps come unpainted, but we provide a sample for color matching at your local hardware store.

## Varieties available:

Round tapered columns/ capitals  
Square tapered columns/ capitals

## Sizes available:

Diameter/ width - 8" , 10" , 12"  
Height: 8' ; 10' ; 12'

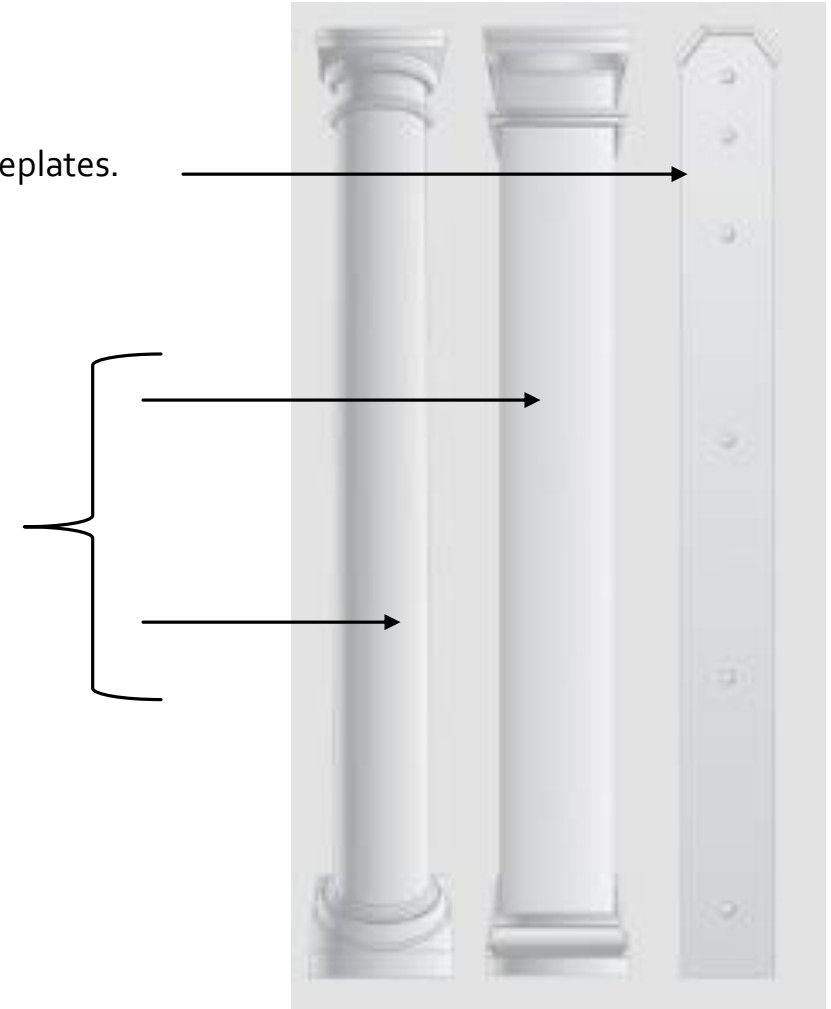

# Single beam vs. Double beam – What's the difference?

 [Click Here to Watch Video!](#)

Then come back to this file to learn even more!



## Double Beam

A 'Double Beam' is two 3x8 Headers parallel to each other offering a 'beefier' aesthetic look. A double beam also allows for larger spacing between posts per engineering. This typically allows you to use less posts than a single beam application.

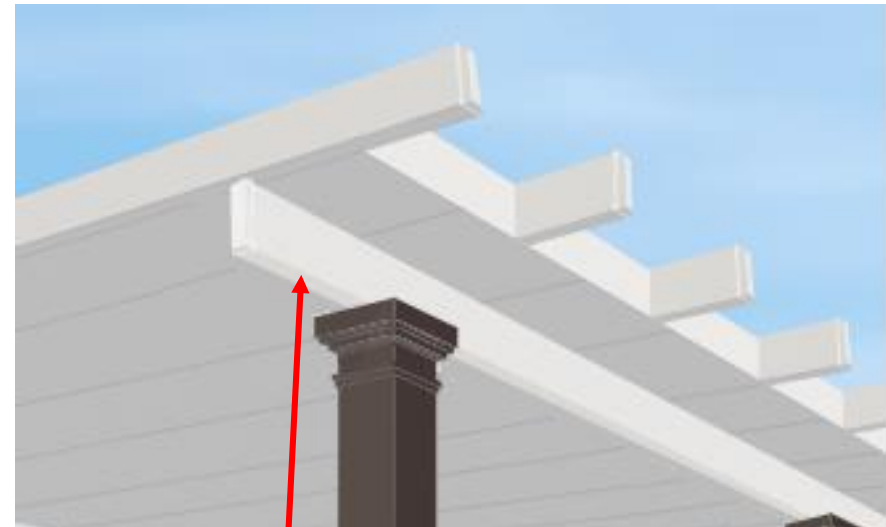

## Single Beam

A "Single beam" is a single 3x8 header. This gives a simpler and more traditional look to your cover. Single beam applications typically require more posts for structural integrity.

Note: all beam end cap styles available for either application

# How will my Post/ Column Option work with my Beam Option?



## Standard Post Kit w/ Single Beam Application

- The beam is placed atop the 3x3 post
- The sideplates sandwich the beam



## Columns w/ Single Beam Application

- The beam is placed atop the 3x3 post *inside the column*
- The Column and capital are decorative encasements



## Standard Post Kit w/ Double Beam Application

- The 3x3 post is placed between the beams
- The beams are placed atop the sideplates



## Columns w/ Double Beam Application

- The 3x3 post is inside the column and extends up to attach to the beams.
- The beams sandwich the 3x3 post
- The Column and capital are decorative encasements

# Steel for max post spacing or freestanding

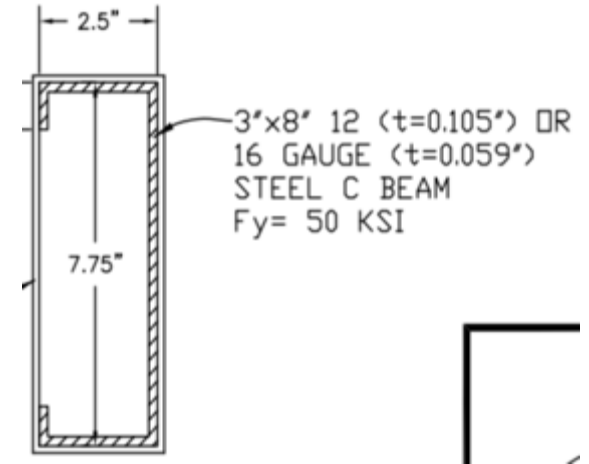
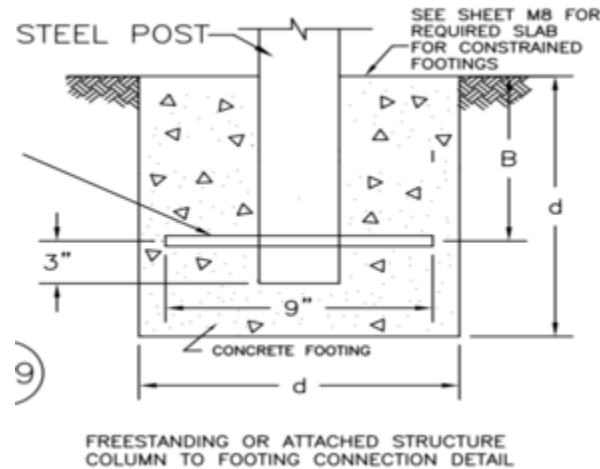

## Steel posts

- Required for all Free Standing Covers
- Optional for attached covers to obtain maximum post spacing
- Required to be sunk into concrete footings below ground level
- Required for all applications if you have paver or dirt landscape (no concrete slab)

## Steel "C" beam

- Required to be placed inside 3x8 header beam whenever steel posts are used in patio cover application
- Allows structural integrity
- Steel beam will not be visible
- Also allows structural ability to hang TVs, Infrared heaters etc. on your patio cover

# Colors – What are my options?



[Click Here to Watch Video!](#)

Customize your Patio Cover in almost any color! →

You can do color combinations i.e. Roofing in White, Trim (Posts, Beams & Border) in Spanish Brown. **Color combinations do NOT change the price of your kit.**

- **Solid Non Insulated Roofing:**  
Available in any color
- **Insulated Roofing:**  
Available in White or Desert Sand only
- **Trim (Posts, Header Beam(s), Rafter tails & Border wrap):**  
Available in any color

Request your FREE color samples (888) 851-8351



Example: Color Combination



Dark Brown



Like: "Coffee w/ Cream"



White



Light Tan w/ Grey Undertone



Off White/Very-light Tan



Grey/ Green Undertone or "Olive"



Rose Undertone  
Think "Santa Fe" style coloring



Graphite  
(All NEW color!)

Medium Grey



# Decorative End Caps – What are my options?

 [Click Here to Watch Video!](#)

Then come back to this file to learn even more!

- The End Caps are placed at the end of each beam and rafter, giving your patio cover a wood-like custom look.
- End caps include False Rafter Tail End Caps and Beam End Caps.
- The quantity of end caps is determined by the size of your cover.



Bevel



Mitre



Corbel



Scallop

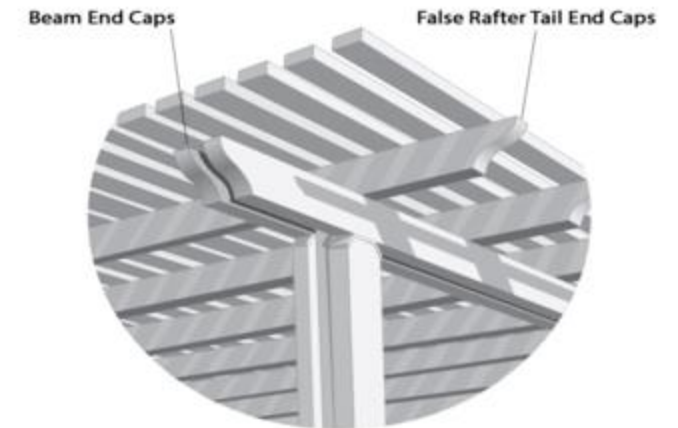



## Fan Beam Kits – Optional Add-on

- ▶ [Click Here to Watch Informative Video!](#)
- ▶ [Click Here to Watch Installation Video!](#)

- Adding fans to your patio cover transforms your patio area into a livable extension of your house.
- Patio Kits Direct provides “Fan Beams” which are 1.5”x2.5” extruded aluminum bars which allow for support of your fan and also allows a conduit to run wires.
- Patio Kits Direct does not provide the actual fan.



Fan beam conduit, built within 3” foam core for Insulated



Solid Insulated



Solid Non insulated



Fan beam runs on top of the roof for non-insulated

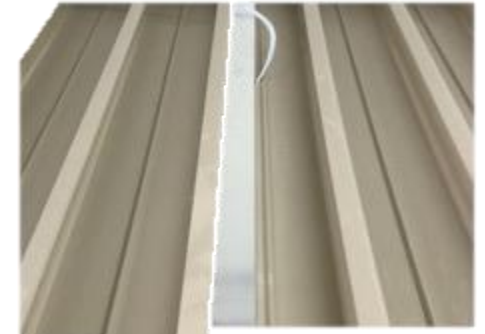

Fan beam cap covers the beam



# Recessed Lighting – Optional Adder

 [Click Here to Watch Video!](#)  
Then come back to this file to learn even more!

Recessed Lighting adds charm and  
ambiance to your outdoor living area.

Lights can be added to both Non  
Insulated and Insulated patio cover kits.  
Must be cut into roof panels upon  
installation

These lights can be purchased from Patio  
Kits Direct or from your local hardware  
store (low profile, LED puck lights)

Patio Kits Direct cost: \$25 per light



# FAQ - Can I walk on my Cover?

 [Click Here to Watch Video!](#)

Then come back to this file to learn even more!

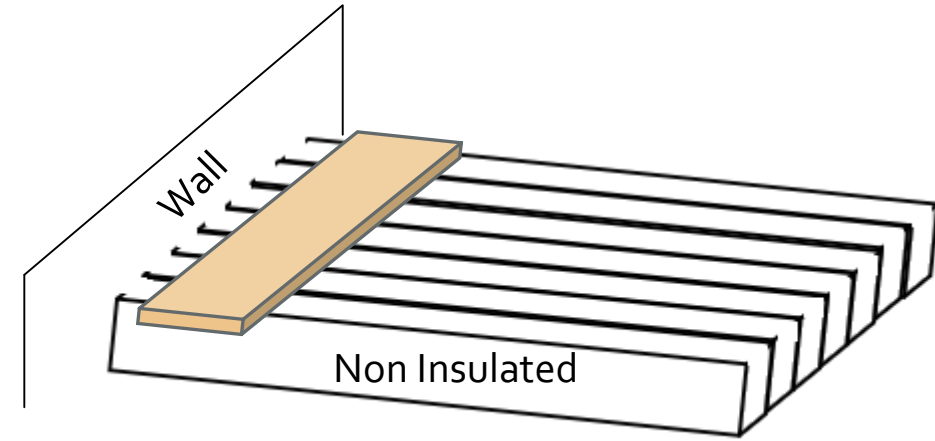
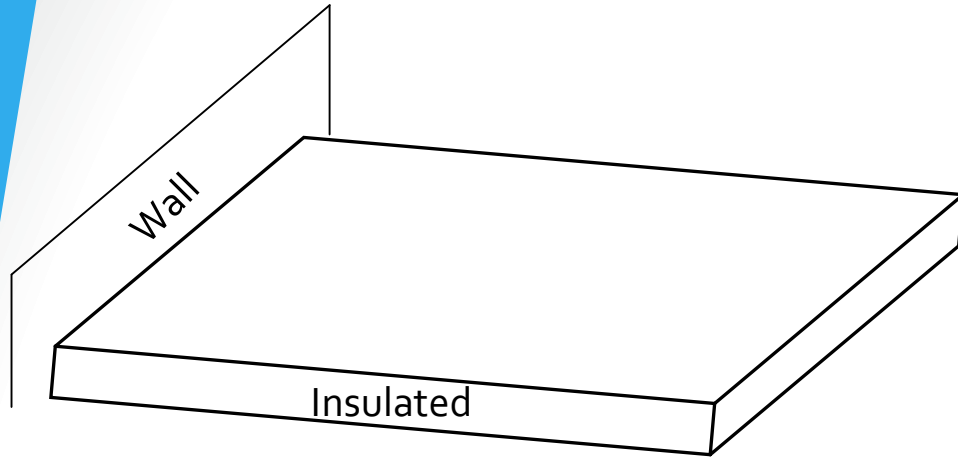

- Yes, you can walk on your insulated cover, to perform maintenance on your house (i.e. washing windows, 2<sup>nd</sup> floor escape route etc).
- No, an insulated cover cannot be used as an additional living area. It is not designed to support the weight of multiple people or a sitting area etc.

- Because the non insulated pans are thinner and "U" shaped, it is not advised to walk upon the patio cover. You can, however, place particle board across the pans, near the house, to distribute weight and walk upon for house maintenance (i.e. washing windows)



"Insulated"

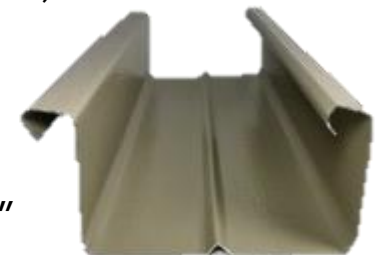

"U-pan"

## FAQ – Is the Rain Noisy on my Solid Cover?



[Click Here to Watch Video!](#)

Then come back to this file to learn even more!

Many people want to know how rain will sound when it hits their aluminum cover, so we recorded a video to show you!

- It's not the 'ting ting' noise that you might imagine.
- Rain sounds very similar to how it sounds hitting your house's roof
- Our aluminum is .018 - .040 gauge in thickness
- Insulated panels buffer the sound a bit more than non-insulated, due to the foam core



# FAQ – Pick Up vs. Delivered to your residence



VS



## Picked up at our factory location:

You can opt to pick up at one of our will call locations, in order to save on delivery fees. 5-7 business days

Requirements: Truck or trailer capable of transporting your longest piece (please ask your sales rep what your longest piece will be – splicing available to accommodate)

## Pick up locations:

- Romoland, CA
- Anaheim, CA
- Sacramento, CA
- Phoenix, AZ
- Stayton, OR

## Delivered via Common Carrier LTL:

We ship via common carrier to **anywhere in the United States!**

Material is either boxed or wood-crated.

Manufacturing and Delivery take approximately 2-3 Weeks

This is convenient for out-of-state customers as well as expedites contractor schedules by delivering directly to the job site!



## FAQ – How do I pay?



**Just give us a call, and let us know your payment preference!**

Buy with confidence! Patio Kits Direct uses the most secure payment platforms available. You will be provided with a sales order #, tracking information and **step-by-step notifications** on the progress of your kit manufacturing (via email and text)

Available Options:

- **Check or electronic check (e-check):** saves customers 2% on merchant charges
- **Credit/Debit Card:** simply give your sales rep you card # over the phone, gain credit card points, and an easy transaction
- **Bank Transfer:** Request that an invoice be sent to you for payment via bank transfer, save 2% on merchant charges!

Like how informative this document has been?



At Patio Kits Direct our #1 goal is superior customer service! We don't simply sell you material like other competitors, we offer:

- **FREE** Comprehensive building instructions/ videos
- **FREE LIVE** phone support during your build (We even **Face-Time!**)
- **FREE** dedicated sales/ build representative EVERY step of the way
- **FREE** Guidance through engineering
- **FREE** Permit documents with purchase of your kit

We are the #1 Platinum Nation-wide dealer of Alumawood Patio Cover Kits. Verify our status and standing with the manufacturer, Amerimax, by contacting:

Amerimax Building Products

(951) 928-1000

NOTE: Amerimax does not sell material directly to the public

